

# **NCG CAM**

**NCG CAM Solutions Ltd.**

**Setting the standard for advanced 3D CAM software**



## **Machine Complex Parts with Ease**

### **NCG CAM Standalone CAM Software**

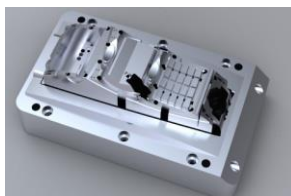
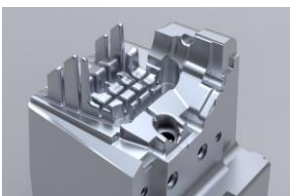

- ✓ Save Time
- ✓ Save Money
- ✓ Increase Profitability

## NCG CAM – Base Module

### Area Clearance Roughing

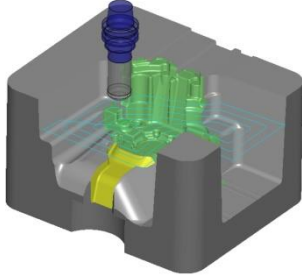

**NCG CAM**'s automatic roughing of surface data is suitable for all types of 2D or 3D forms, creating an optimised, smooth cutting motion for high speed machining (HSM) while maintaining part accuracy, cutting tool life and machine tool life. All cutters and tool-holders are collision protected to maximise efficiency and stock model visualisation of the machined part is available at every stage of the manufacturing process.

**NCG CAM** will always attempt to helix into the job when roughing, but will then automatically adapt to a profile ramping condition by ramping down in Z, while following the toolpath if a helix entry is not possible.

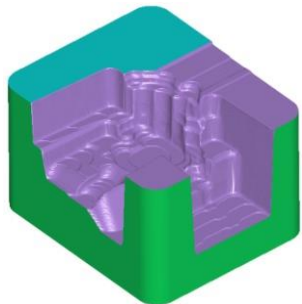

In any area below the cutter that is too small to be area cleared, based on indexable tipped milling tooling which can not centre cut or plunge, the passes are discarded automatically. **NCG CAM** is then able to detect these areas and locally machine them with rest roughing, avoiding almost all "air cutting".

**NCG CAM** fully gouge protects the cutting tool and the tool-holder, which is very important when you may have a tool-holder and/or tool that is not long enough to reach. Likewise, it also provides gouge protection when machining using 5-axis machine tools ( 3+2 axis ), and machining areas which might be deemed inaccessible with the standard 3-axis approach.

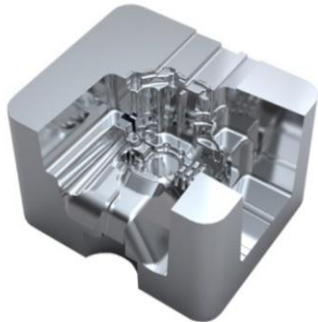

Cutting tools and tool-holders can be specified either from a standard tooling catalogue or users can define their own custom libraries using the holder designer. These can then be stored specific to each machine tool, or material being machined.

### Core Roughing

**NCG CAM** has an additional routine for roughing which is ideal for core forms, where the machinist wants to rough away the material by machining from the outside, whilst maintaining climb milling. All toolpaths start in fresh-air at the given Z-depth, and work into the middle.

**NCG CAM** creates a safe boundary from the outside form of the core. All toolpaths then start from this safe boundary, approach the material with a lead on arc, machine with no more than half the diameter of the cutter, then lead off with an arc away from the material back into the safe zone.

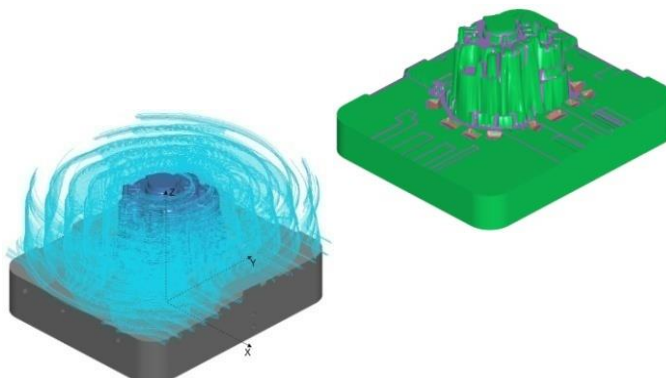

**Raster Roughing & Zig-Zag Roughing**

Zig-zag roughing in **NCG CAM** will take linear cuts across the job at fixed Z levels, similar to area clearance or core roughing passes. As these passes are linear, there is far less data involved and fewer changes of machine directions. At each level a profile pass is performed to remove the cusps around the parts profile at that level, before moving down to the next Z-level.

When creating the passes it is possible to stagger the passes. This is of benefit if roughing with a ball-nose cutter as the cusp height on the bottom of the cutter is kept to a minimum. When linking zig-zag roughing passes, there are options for one-way, bi-directional and zig-zag for the stock removal passes and climb or conventional for the profile pass.

**NCG CAM** has a raster roughing routine that will allow the roughing out of a part with a raster strategy that is also broken into Z-bands. When the cutter comes up against the form it follows the form up to the top of the Z-band for those passes; this ensures there is not a big step left. If using a ball-nose cutter the passes can be staggered to leave the minimum cusp height from the bottom of the cutter. The linking for raster roughing passes has options for one-way and bi-directional.

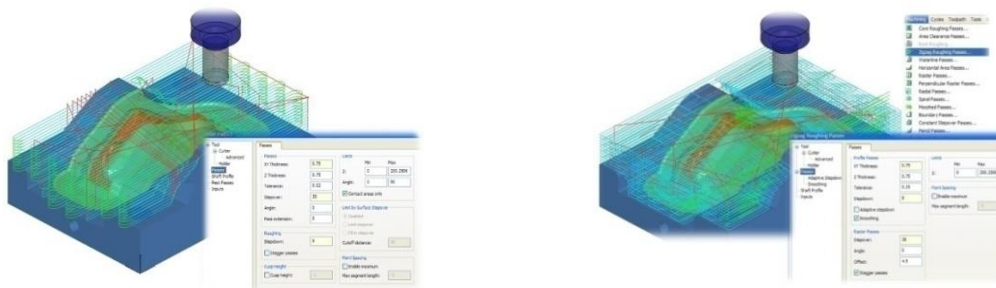

Zig-zag and raster roughing are ideally suited to softer materials and controllers with a smaller look ahead or that are not able to read/load data very fast.

**Adaptive Area Clearance**

Adaptive area clearance eliminates full width cuts using a concept similar to trochoidal milling.

This cutting technique is aimed towards high speed machining with solid carbide cutters. It provides the ability to safely cut using the full length of the flute at the optimum cutting speed for the material and part. Tool wear is spread evenly, cutting more on the flute than the bottom of the cutter, reducing deflection and the potential for vibration by maintaining a constant load on the cutter. The technique is particularly suitable for cutting hard materials and also some electrode manufacturing. The strategy automatically adjusts the toolpath for efficient and safe machining, improving cutting conditions and allowing more consistent and possibly higher machining speeds to be maintained.

As well as significantly improving tooling life, adaptive area clearance can reduce machining time by an average of 25% over conventional roughing as the machine uses the full flute length of the cutting tool, and the machine runs at the optimum speed without exceeding its limits at an isolated point.

The linking order is very important, so the linking is done at the same time as the passes are calculated.

After each level has been cleared using all the flute length, additional passes can be made to reduce the size of the terraces on the 3D form.

These additional passes will be either profile or clearance passes as required, depending on the material remaining or the shape of the part.

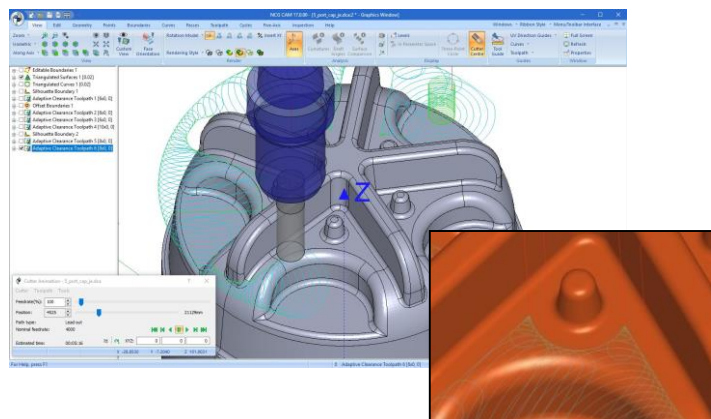



**Vibration Free Machining**

When creating area clearance or core roughing toolpaths, **NCG CAM** has an option for anti-vibration machining. This feature greatly reduces vibration, an important feature for all machinists. This helps to maintain consistent cutting conditions, prolonging the life of the machine tool and cutting tools. In turn this produces a more accurate part at the roughing and rest roughing stages, enabling the finishing toolpaths to provide consistently more accurate parts with a good surface finish, saving both time and money. This is done by holding the cutter off the side walls when cutting the bottom and lifting the cutter up slightly when cutting the sides

**Feed-Rate Optimisation**

**NCG CAM** has feed-rate optimisation for area-clearance, core roughing, rest roughing and water-line machining. The software is aware of the cutting conditions, if the current toolpath is machining an external corner, then the feed-rate specified can be maintained. In areas such as internal corners where the cutter will be in full contact, **NCG CAM** looks ahead and adjusts the feed-rate down to maintain accuracy and prolong tool-life.

When **NCG CAM** is performing a ramping entry move for area clearance roughing, the ramping feedrate is used. Once the cutter is to depth, the cutting feed-rate can also be reduced as this first cut will be the full width of the cutter. This is then returned to the normal feed-rate once the cutter is not making a full width cut.

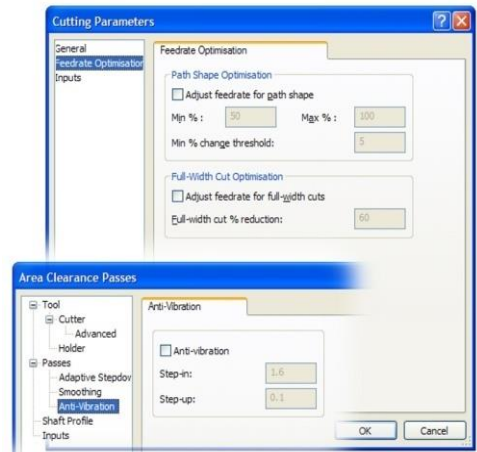

**Rest Roughing**

**NCG CAM's** rest roughing can be done in two ways.

The user creates the first roughing toolpath from a solid block of material as previously described, in area clearance or core roughing. Rest roughing is then created automatically by selecting the next cutting tool, along with the previous toolpath(s). The rest roughing toolpath is created, eliminating fresh air cutting and only machining in the areas the previous cutting tool has missed. Another stock model can then be made with the combined toolpaths to show the progression.

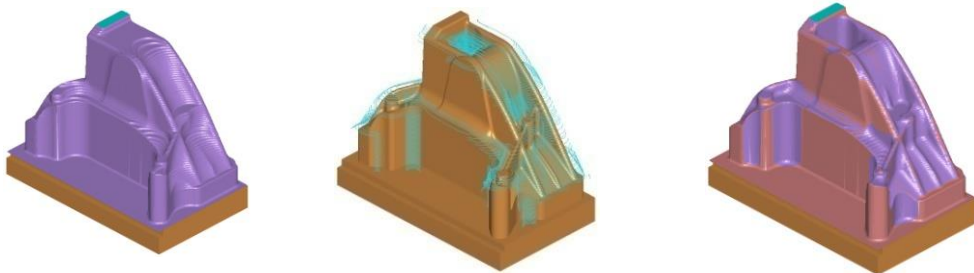

Rest roughing can also be used when machining castings. The passes can be trimmed back to another surface model such as the casting form seen below. The resultant rest toolpath is fast to create and cuts out multiple tooling operations, fresh air cutting and set-up time.

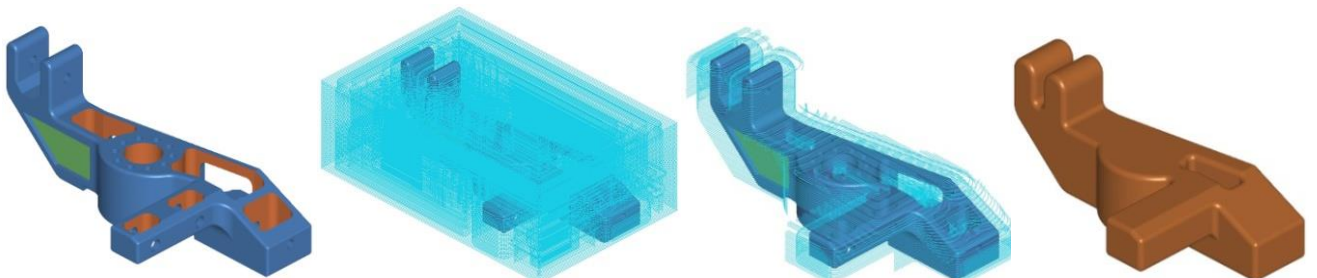

**Stock Models**

Stock models can be created from one or more toolpaths, which can be 3, 3+2 or 5 axis, or a combination. Stock models can be used for the visualisation of the machined part on the screen, eliminating any costly test cutting.

The stock model can be used with the part surface and the material depth comparison tool to 'see' the amount of material that still needs to be machined. Sectioning with a clipping plane can give useful information on remaining material.

These stock models can be used for rest machining subsequent operations, minimising fresh air cutting and so reducing the machining time.

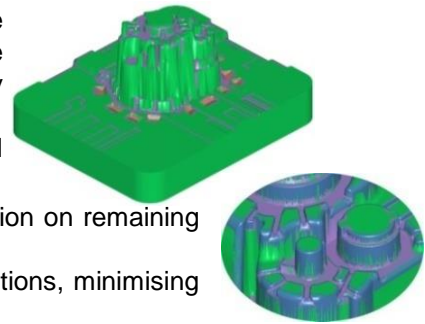

**Waterline ( Z -Level ) Machining Using Surface Contact Angles**

Waterline passes can be used for semi-finish and finish machining the more vertical areas of a part. If a slope angle is specified, for example between 30° – 90°, the steeper areas are machined, leaving the shallower areas between 0° – 30° for more appropriate strategies. These passes can be constrained to a boundary or by the selected surfaces. Waterline machining also has the feed-rate optimisation option.

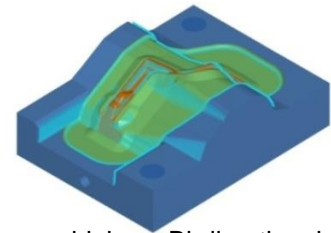

Linking options for waterline passes include bi-directional and one-way machining. Bi-directional machining will maintain contact with the part by climb milling one-way, then conventional milling the other, but should only be used for non-critical machining. One-way machining is the default and ensures a climb milling cutting action, maintaining tool-life accuracy and good surface finish. The linking move may be on the surface, or can be forced off the surface with user defined angle of lead in / out and lead extension to help with cutting some specialist alloy materials. It is also possible to set conventional milling if required.

**Horizontal Area & Horizontal Core Machining**

Horizontal area passes are used to finish machine flat surfaces more efficiently by using flat bottom cutters. Horizontal area passes are aimed towards cavities, while horizontal core passes start off the block and machine in from the side making them more suitable for core forms, whilst extending tool life.



Horizontal area and horizontal core machining both have similar smoothing characteristics to area clearance and can detect all flat surfaces on a part, with or without using boundaries.

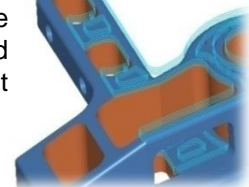

Should the user require to machine these flat areas with more than one pass, the passes can be axially (along the tool axis) offset by a user any number of times.

**Raster & Perpendicular Raster Machining**

Raster toolpaths are used for finishing in conjunction with steep and shallow cutter contact angles and another machining routine, typically waterline. The raster toolpath would have a cutter contact angle of around 0° – 40° and waterline 30° – 90°. This approach uses the best machining combination for finishing complex 3D surfaces and can be used on older CNC milling machines or high speed machines alike. Raster passes can be constrained to a boundary or by the selected surfaces.

Perpendicular raster toolpaths are used for finish machining the whole component with a constant surface finish and at the same time maintain a climb milling direction. Perpendicular as it suggests, machines using raster passes in one direction. It omits passes on the steep faces that are parallel with the cutting direction and then fills in the gaps with another raster toolpath at 90° to the previous, thus maintaining surface finish and climb machining.

Linking options include one-way and bi-directional, plus options for down-milling (for 3D machining with carbide-insert cutters) and up-milling (for 3D finishing with solid carbide ball cutters).

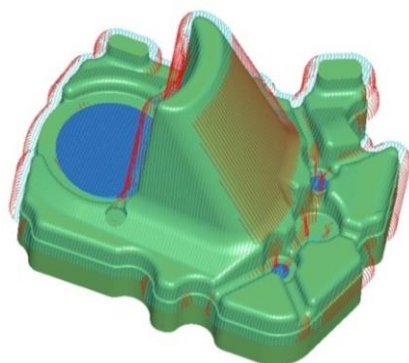

### Spiral Machining

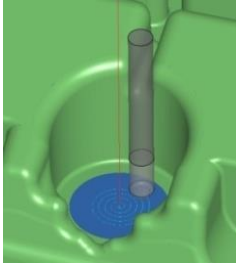

This creates an archimedean spiral toolpath from a given focal point, generating a constant contact as it machines within a given boundary. It is ideally suited for use on round shallow areas using contact angles between  $0^\circ - 30^\circ$ , in conjunction with the waterline machining for the more vertical faces  $30^\circ - 90^\circ$ . These passes can be constrained to a boundary or by the selected surfaces.

### Radial Machining

Similar to spiral machining, radial machining also starts from a focal point, providing the user with the ability to create radial passes. Some extra options include the ability to stop short of the centre where the radial passes become very dense.

The focal point for the radial or spiral machining is detected automatically, or can be determined by the user. This routine can also be used in conjunction with cutter contact angles. These passes can be constrained to a boundary or by the selected surfaces.

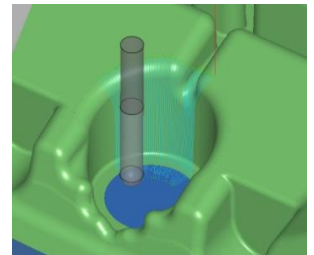

### 3D Constant Offset Machining

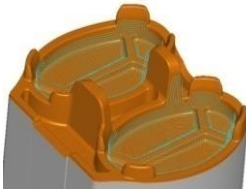

The constant offset machining strategy is used for maintaining a constant equidistant step-over from one tool pass to the next, irrespective of the slope angle of the part. This can also be used in conjunction with cutter contact angles, within any boundary or applied to the whole part.

### Combined Passes – Waterline & Constant Stepmover

Combining Waterline and Constant Stepmover passes allows the creation of Waterline Passes between the upper angle of  $90^\circ$  down to a specified lower angle. Constant Stepmover Passes are then created to 'fill in' the shallow areas between the specified lower angle and  $0^\circ$ .

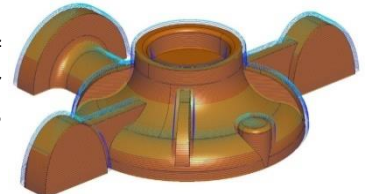

Linking is also a single operation from the top down, so that the linking order will be a combination of waterline and constant stepover, switching between the two types of passes as the tool descends.

Combining these passes provides smoother finishing for more complex shapes. as any tool wear is automatically hidden in the passes. The load on the cutter is more consistent too.

### Morph Machining

Morph machining allows the user to control a toolpath using flow boundaries and direction profiles. This cavity form is an ideal example of this strategy. Morph machining can be used in conjunction with cutter contact angles.



### Pencil Milling



The pencil milling routine is to finish corners which might otherwise have cusp marks left from previous machining operations. This is ideal for machining into corners where the surface radius is the same as the cutter corner radius. Single pass pencil milling gives a high surface finish ready for polishing. When machining, the toolpath maintains climb milling as default and can be used in conjunction with cutter contact angles. As with all toolpaths in **NCG CAM** they can be animated alone or with holders. See the pencil milling example to the left.



**Parallel Pencil Milling**

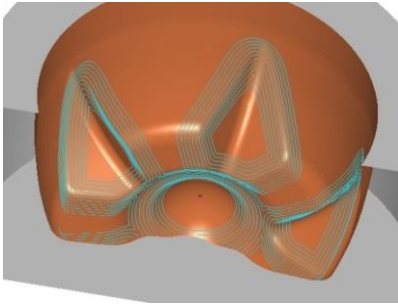

Parallel pencil milling is an extension of pencil milling, in that the user can determine the number and step-over of multiple-passes either side of the pencil toolpath. This is particularly useful when the previous cutting tool has not been able to machine all the internal corner radii to size. These multiple passes, will machine the remaining internal radii and any additional material left by the previous cutting tool, machining from the outside into the corner. This creates a good surface finish to the true form and can be used in conjunction with cutter contact angles.

**Rest Finishing Machining**

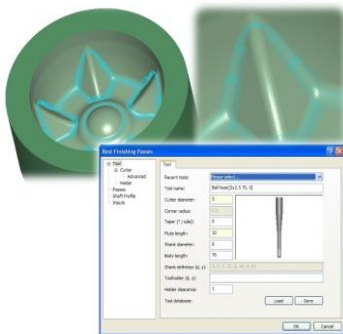

The rest finishing is aimed at semi-finishing and finishing internal corners. The area machined is limited by a reference cutter, defined by the user. A ball nose cutter is used, steep areas are separated from shallow areas, like all other types of passes the cutter and holder are protected from gouging. Spiral like linking allows for the milling direction to be maintained in the shallow areas. In the steep areas, the cutter is kept on the part as much as possible, reducing any air cutting.

**Corner Offset Machining**

Corner offset machining is similar to constant offset machining. However with this technique, rather than starting from an outside boundary and working in towards the centre of the part, a set of pencil milling passes are created on the features of the part, then a toolpath calculated over the whole part from those features. The toolpath maintains a constant and equidistant surface finish over the whole part. The resultant surface finish in the corner is significantly better than 3D constant offset machining depending on the shape of the part, as the toolpath follows the 3D form and features and can be used in conjunction with cutter contact angles.

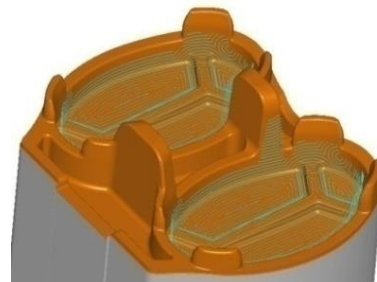

**Boundary Machining**



Boundary machining, machines along an open or closed boundary profile. A negative machining thickness can be used to machine at constant depth below the surface being machined and can be used in conjunction with cutter contact angles.

Boundary machining can be used for the machining of mould tool runner detail, or applied to engraving boundary shapes and text which can be generated using the Windows True Type™ fonts within the **NCG CAM** system. The available fonts will depend on the users Windows™ operating system.

**True Surface Machining**

**NCG CAM** machines using triangulations as standard, which are quick to calculate and check against for gouge free machining. True surface machining is optional for users to select, should they wish. Machining the surfaces spaces the points in the NC Tape file more uniformly, giving a better / smoother machine movement on some machine tools. However, the calculations to ensure the machining is gouge free will take longer in most cases.

The better the surface finish means less hand polishing, which saves time and money, it also reduces any mis-match / flash caused by polishing rolling/belling corners.

**Surface Analysis**

The curvature function allows the user to quickly find out what the smallest radii is on the part to aid cutter selection. Internal and external radii are filterable and the radii range user definable.

For quick identification this is done graphically using a colour overlay to the surfaces and the cursor tool tip provides an accurate size.

The stock model analysis uses the triangulated surfaces and a stock model to provide the depth of the remaining material.

This works for 3-axis or 3+2 axis parts, using similar type of graphical display as for the curvatures.

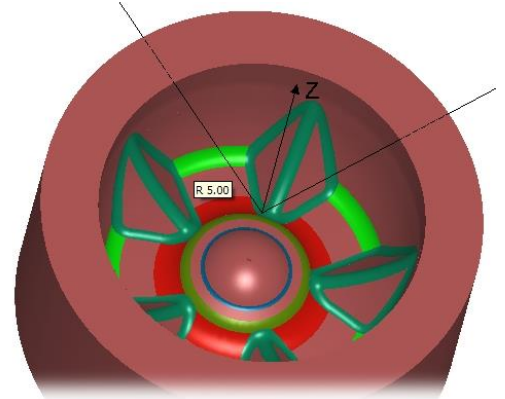
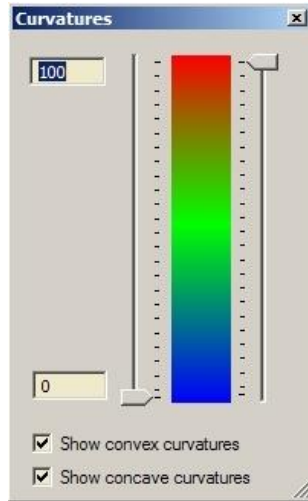

A draft function shows draft angles (tapers from the tool axis) using a similar style of graphical display as the curvature.

This could aid the selection of a tapered cutter and or type of tool path.

PATTERNMAKING

**Along Curve Machining and 2D Cutter Compensation**

Machining along a curve is just as it says - it is the curve that is machined not the surface data. This will allow a toolpath to be generated below the surfaces if needed.

Curves can be read in from the geometry file or extracted from the model. If extracted from the model the curve may be 3D and will be respected as 3D when machined. Curves can also be extracted as 2D curves to be used for 2D machining. These extracted curves contain accurate lines and arcs to get the desired NC Tape file with circular arc moves. There is also a convert curve to boundary function

Open curves can be joined to get a continuous profile – often in a model it will be several bits of curve that require joining to reduce the number of retract moves.

The along curve machining supports 2D cutter compensation (G41 & G42 or cutter left/cutter right). This enables 2D profiles to be sized on the machine tool; the toolpath has arc fitting for optimised output. Cutter compensation is only available on a 2D curve.

Creating multiple points for start hints allows the user control over the start position and for several curves to be machined within the same operation.

A pass extension will allow the toolpath to be extended out (open profiles) to the cutter can be forced to start clear of the part, for a better cutter approach and cutting conditions.

The optional pass overlap allows the cutter to overlap the starting position (closed profiles) to help reduce a 'tool line', giving a better surface finish.

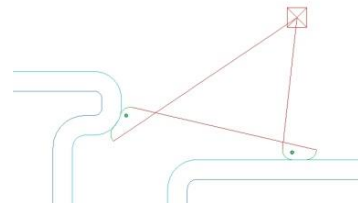
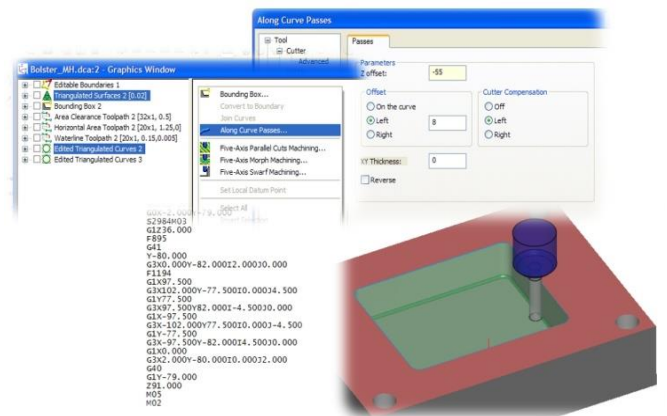



**3+2 Five Axis Machining**

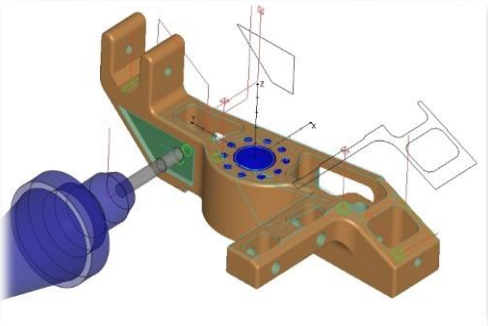

3+2 multi-axis machining has an easy to use graphical interface, including being able to snap to the surface normal for machining.

This enables the user to reach deep and complex areas by rotating the part or the head of the machine tool through a combination of A, B or C axis motion. Once in position, all machining routines are available and are fully gouge protected for the tooling and the holder and can be used in conjunction with cutter contact angles.

**Rest Areas Options**

**NCG CAM** has rest area machining options on all the finishing routines, such as waterline, raster, spiral, radial, constant step-over, parallel pencil passes, corner offset passes, morphed and boundary passes.

This allows the input of the previously used cutter size or reference cutter to be specified. Passes will only be generated in areas that are inaccessible to the reference cutter. All rest area calculations can be done without the need for boundaries, and steep and shallow cutter contact angles can be applied.

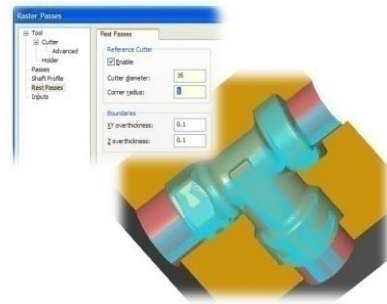

**Ease of Use in Changing Machining Area Boundaries**

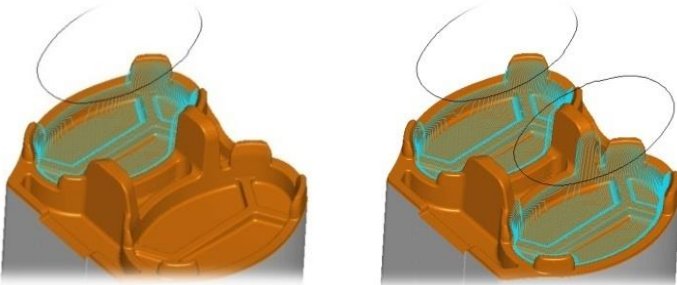

**NCG CAM** has an input tab available on all dialogs, once the passes have been made. This input tab, allows the user to change the input boundary or surfaces and re-calculate the passes.

**Offset Protection Surfaces**

Although **NCG CAM** is not a modeling system, it has some functions to enable the user to modify and protect surfaces ready for manufacture. Offset surface is a useful feature for the protection of the split-line or shut-off of a mould-tool, but is ideally suited to tool repair work where you want to stay off polished surfaces in the mould, further protecting those surfaces during machining operations.

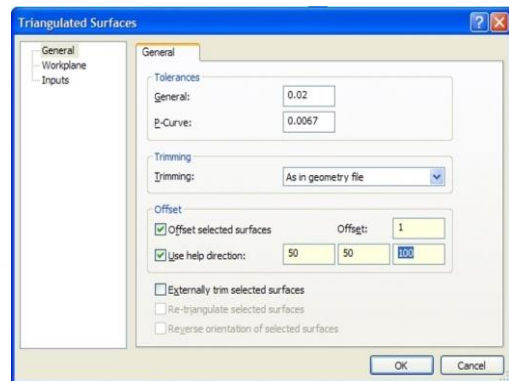
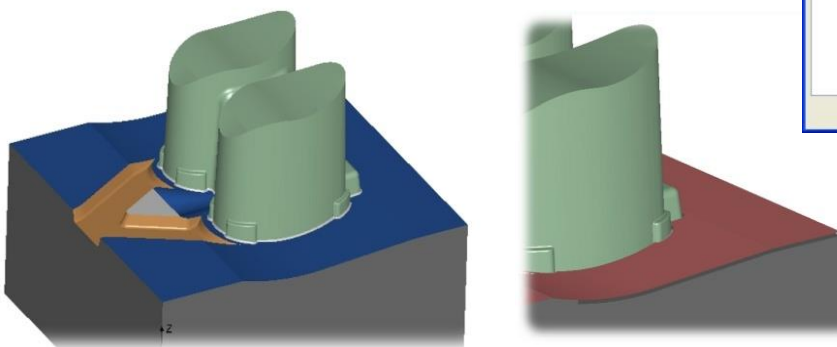

**Edit Surface Trimming Holes & Ruled Surface**

When machining components or moulds, it is sometimes necessary to remove holes or other apertures from surfaces to enable more efficient manufacture. **NCG CAM** has functionality which will enable the user to remove individual holes, even on doubly curved surfaces, or remove the complete inside trimming edges as shown right.



**NCG CAM** also has the ability to create internal fillets, this can in some instances allow a more flowing toolpath. Planar patches can also be create to cap or protect areas if needed. It is also possible to create a ruled surface between 2 curves to aid machining past the end of a surface.

**Hole Detection & Drilling**

**NCG CAM** has automatic hole detection for all holes, chamfers and cones that form part of the same hole composite. When detecting holes they can be filtered by minimum or maximum diameters, depth, angle (tool axis) colour.

**NCG CAM** will then display a number of folders representing all the axis directions found. These can then be sub-divided into drilling data folders with holes of the same size and depth. The various cycles can then be applied. Cylindrical holes, chamfers and cones, that have the same tool axis and drilling start point are connected, so multiple cycle operations can be performed.

Cycles supported on all post-processors are: spot drilling, deep drilling, deep drilling with chip break, reaming, tapping left and right hand, thread milling (internal, external, left have and right hand), boring, boring with spindle orientation and bore milling. Bore milling may be emulated for some controllers.

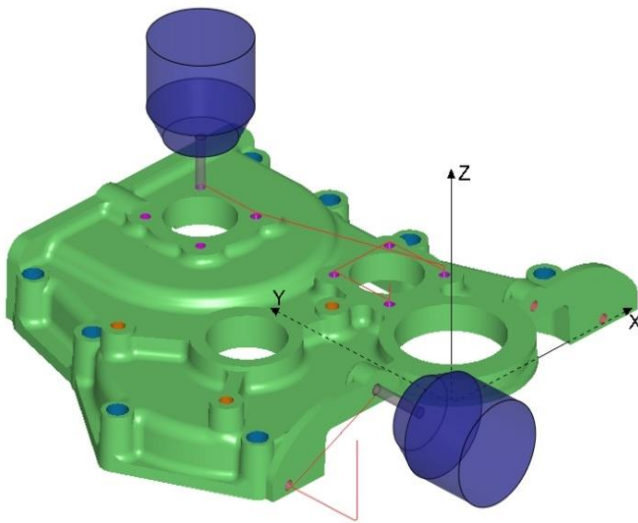
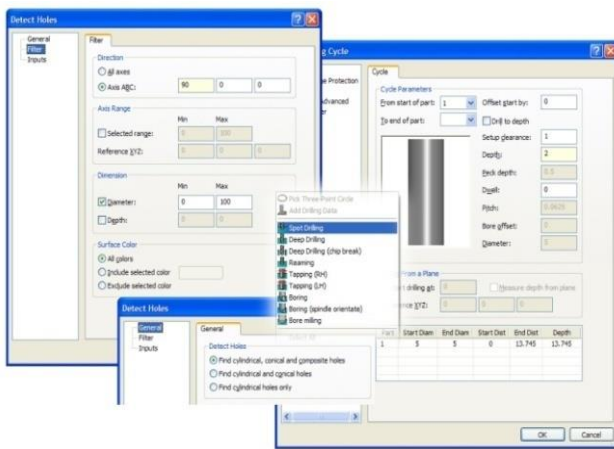

**Cycle**

Cycle Parameters

Setup clearance: 1 From start of part: 1

Depth: 71.0003 To end of part:

Peck depth: 4.3999 Offset start by: 0

Dwell: 0  Drill to depth

Diameter: 43.999  Chip break

Bore Parameters

Spindle orientate

Bore offset: 0

Pre-Drill diameter: 0

Thread Parameters

Pitch: 0.55

Threads per step: 1

Number of starts: 1

Left hand  Right hand

Internal  External

Climb milling

Drilling From a Plane

Start drilling at: 0  Measure depth from plane

Reference XYZ: 0 0 0

Part	Start Diam	End Diam	Start Dist	End Dist	Depth
1	43.999	40.999	0	1.5	1.5
2	41	41	1.5	6.5	5
3	32.999	31.999	6.5	7	0.5
4	32	32	7	69.5	62.5
5	31.999	34.999	69.5	71	1.5

**Electrode Machining**

Within **NCG CAM** there is a spark-gap variable that can be used to aid the manufacturing of electrodes for EDM. By using the spark-gap variable in conjunction with the marcos, the user can make another electrode with different spark-gap with very little input.

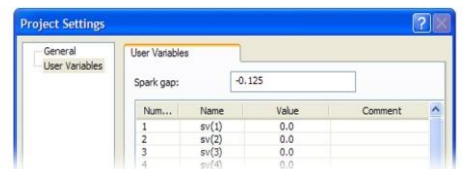

**Tool-Holder & Cutting Tool Libraries**

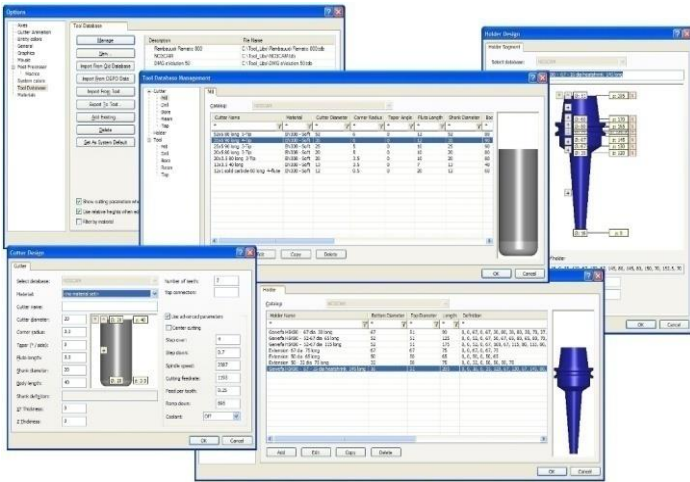

**NCG CAM** can store a wide range of tool-holders and cutting tools in separate libraries, so the users can set-up a range of holders which are suitable for use with the cutting tool. Both the cutting tools and holders can be created graphically and then stored in the relevant library. These libraries can be specified and named for individual machine tools or materials, and set-up to have tool numbers, spindle speeds, rapid feed, ramp feed, cutting feed and coolant or air blast options.

**Shop Floor Documentation**

Tool sheets are automatically created in XML / HTML format and have the option to include graphics. The tool sheets are vital if the part is to be machined by someone other than the person who programmed it. For parts that are machined quite often, (a perfect example being a forge die that may be on the machine for a re-cut 2 or 3 times a week), the tooling sheet ensures the operator knows which tool and tool size machines each part.

**Part Inspection**

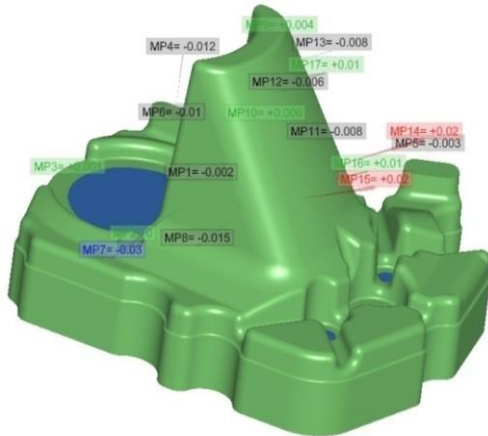

**NCG CAM** has an inspection module which allows the machined part to be inspected while still on the CNC machine tool.

This is particularly useful for large components which take valuable time to take off the machine tool, send to the inspection department, and set-up again if re-machining is required. Other applications that the part inspection is useful for complex 3D doubly curved components which can only be inspected to the original surface model, or for the checking of spark-erosion electrodes for accuracy of negative spark-gap allowances prior to being used in the spark erosion process.

Inspection vectors are created graphically on the surface model by the user, or a blanket grid can be made automatically within a given boundary. These vectors are then converted to inspection probe motions, which are sent to the CNC machine.

This in turn sends back data to the part inspection file which compares the machined part with the original surfaces. The results can be displayed graphically, in tabular form, as a table on the computer screen, or as an Excel spreadsheet.

Since the inspection takes place on the machine tool, should there be the need for any further machining, it can be carried out straight away, saving valuable time.

The part inspection is currently available on CNC machines with Heidenhain controls that support probing.

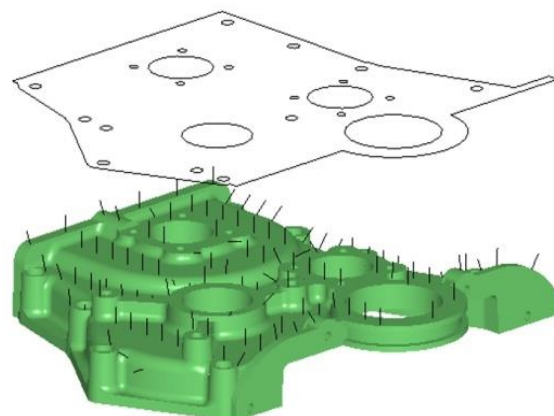



## NCG CAM – Simultaneous 5-Axis Add-on Module

### Simultaneous 5-axis Add-on Module

NCG CAM simultaneous 5-axis module is an add-on to the base module of NCG CAM. It does not run as a standalone product.

Simultaneous 5-axis allows the use of shorter, more rigid cutters for higher feed-rates and optimised machining time. All toolpaths have automatic collision prevention for both cutter and tool-holder.

The 5-axis is aimed at finishing operations, supporting cutter types - ball-nose, flat bottomed, bull-nosed, taper cutters. Due to the complexity of many 5-axis toolpaths, the passes and linking are performed as a single operation. The 5-axis also needs to see the surfaces and any curves as NURB's.

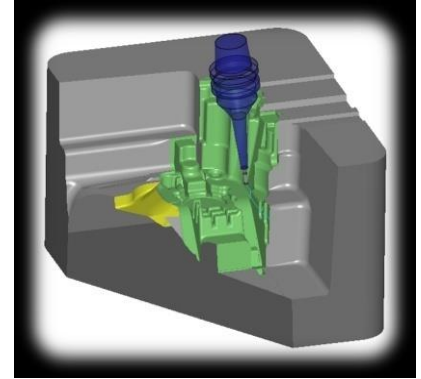

### Advanced 5-axis Toolpaths for Mould & Die Machining

Tool axis control allows the user to have some control of how the tool tilts:

- Tilt through or away from a point
- Tilt through or away from a curve
- Full gouge avoidance of cutter and holder
- Minimise side tilt to avoid collision
- Lead/lag and tilt angles available
- Minimal tilt to avoid holder collisions
- 3, 4, or 5-axis options. When selecting 4-axis, the user has to say which axis the 4<sup>th</sup> axis rotates about.

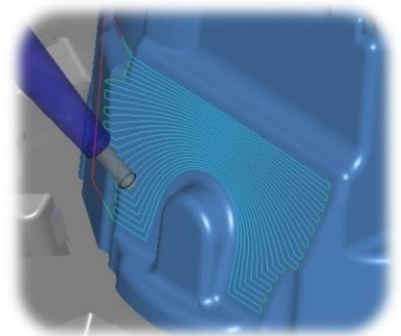

The options available may change depending on the type of 5-axis toolpath. In the linking the user can control the entry / exit moves and the transition.

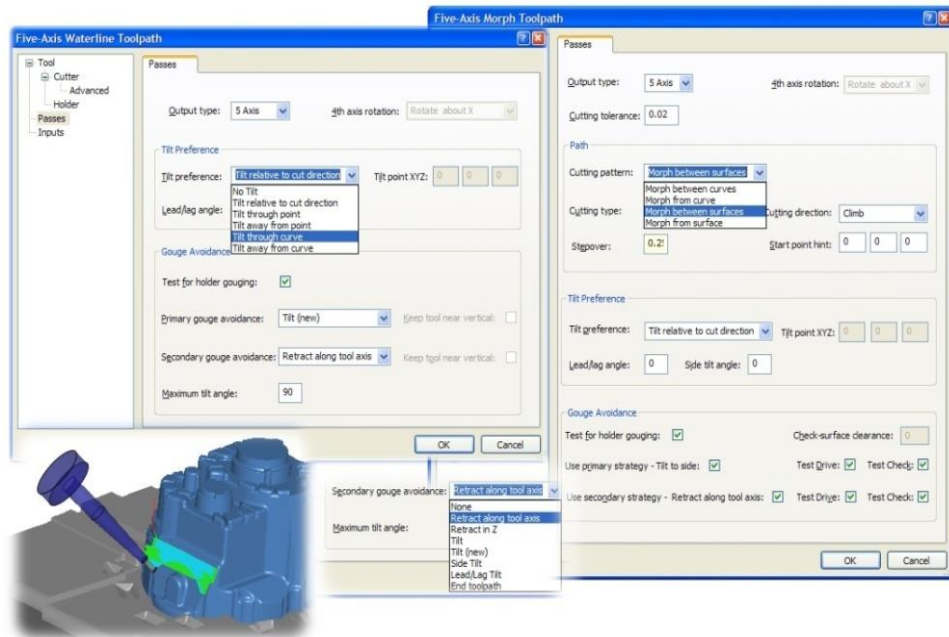

Surfaces are separated into drive surfaces and check surfaces. The drive surface is the surface that is machined, the check surfaces are used to limit the machining area. It is possible to use check curves over check surfaces. It is not uncommon to have 2 sets of check surface/curves.

**Swarf Machining**

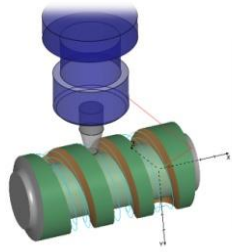
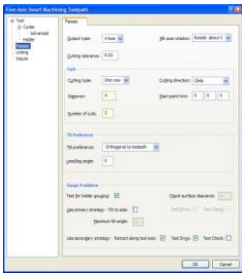

In **NCG CAM** using swarf machining allows the side of the cutter to be used, keeping it orthogonal with the surface; a lead/lag angle can still be applied if needed. With swarf machining it is also possible to offset the passes along the tool-axis.

**Morph Surface Machining**

Morph surface machining machines the drive surface, with options for zig-zag, one-way and spiral - additional options for climb or conventional milling are also available.

Though the shape of the part is a major factor, the spiral option can result with the toolpath staying on the part all the time, whereas another style of toolpath would have to retract from the surfaces more often. When morphing between two surfaces/curves the step-over can change depending on the shape of the part.

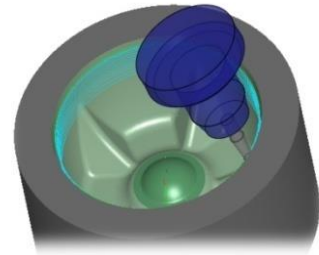

**Parallel Cut Surface Machining**

Parallel cut surface machining machines a drive surface in parallel cuts, at an angle to a specific axis, X, Y and Z .

Machining options allow for the cutter to be kept normal to the surface and zigzag, one-way and spiral options for the cutting direction.

**Automatic 3 to 5-axis Conversion**

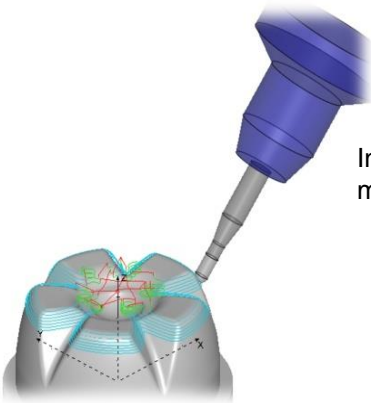

**NCG CAM** has the ability to automatically convert some types of 3-axis toolpaths to a 5-axis toolpath, which can save valuable machining time, tooling costs and tool life.

In most cases the 3 to 5-axis conversion of existing **NCG CAM** toolpath is for minimal side tilt only to avoid holder collisions, but other options include:

- 4 or 5-axis control
- Tilt away or through a point
- Tilt away or through a curve
- Lead / lag angles and side tilt
- Fixed tilt angle

**Machine Tool Simulation**

The machine tool simulation allows the user to simulate the machine movement. This is generally very important for 5-axis toolpaths, where it is often difficult to visualise the real position of the machine when animating the toolpath. By running the toolpath through the machine simulation, you can be sure there will be no collision between the machine head and the bed/table of the machine.

Like the toolpath animator the user can control the simulation speed, zoom in/out. Should there be a collision, it will be highlighted graphically and a dialogue is displayed to inform the user. The machine tool simulation is also able to simulate the stock being removed pass by pass.

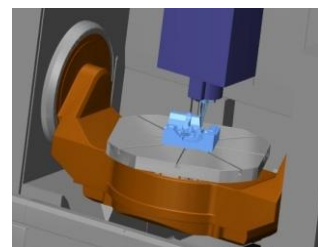
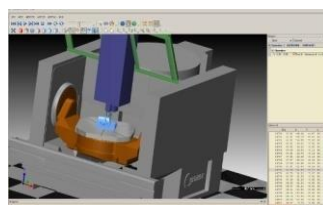
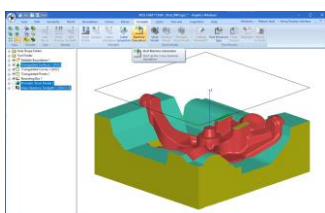

## NCG CAM – General

### Multi-tasking Capability & Parallel Processing

The **NCG CAM** kernel was one of the first CAM systems to utilise multi-threading capabilities and allow the users to calculate 2 or more toolpaths simultaneously. With **NCG CAM** the user can keep working, even making use of operations that have not finished calculating with the new task being placed in a queue until a processor is available.

Parallel processing improves the use of CPU's further still, by significantly speeding up calculation time already improved by multi-threading. For example, when calculating rest finishing passes, rather than using a single processor, **NCG CAM** will spread the calculation among all the available processors.

Almost all PC's today will be dual core, if not quad core and so support parallel processing. Basically, this means that your PC could support between 2 and 8 CPU's in one form or another.

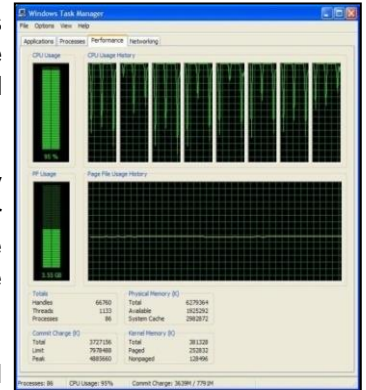

### Macros

**NCG CAM** allows the user to record operations to a macro; that macro can then be used to automate the machining of a similar part. This is particularly useful when using the spark gap variable.

### Compatibility

**NCG CAM** offers a number of different translators allowing different model formats to be opened. Standard within the software are, IGES, VDA-fs, STL, STEP, RAW and CLD.

Translators for PARASOLID™, SolidWorks™, Pro/ENGINEER™ / Creo™, CATIA™ versions 4 & 5 are additional options. IGES, SolidWorks™ and Pro/ENGINEER™ / Creo™ have model associativity.

### Model Associativity

The **NCG CAM** model associativity can detect if the IGES, SolidWorks™ or Pro/ENGINEER™ / Creo™, Step, VDA-fs, Parasolid part has been changed. The user is informed and has the option to automatically recalculate the toolpaths to the new model.

### System Requirements

Operating system compatibility: Windows 7™ Windows 8™ Windows 10™ on a 64-bit platform, 8GB RAM (minimum).

### Post-processors

Internal macro post processors are included for Heidenhain and ISO formats, these are user configurable from within **NCG CAM**. There is also a standard APT output for the G-Post™ processor and G-Post™ post-processors are available.

Post-processors for most 3-axis and 5-axis CNC machine tools are available. These too can be configured from a user-interface.

### Training

Just 1 day of training is all that is required to get a user able to machine a real part (3-axis).

An additional day is recommended to cover the 5-axis module, finer details and less used operations.



**Local Reseller Contact Details:**



**Head Office:**

NCG CAM Solutions Ltd  
7 Trust Court, Chivers Way  
Histon, Cambridge, Cambridgeshire  
CB24 9PW, UK

Tel: +44 (0)1223 236408  
+44 (0)1353 699840  
Email: [estelle@ncgcam.com](mailto:estelle@ncgcam.com)  
Web: [www.ncgcam.com](http://www.ncgcam.com)